

## Uponor Smatrix Base PRO Controller X-148 Modbus RTU

EN

Installation manual

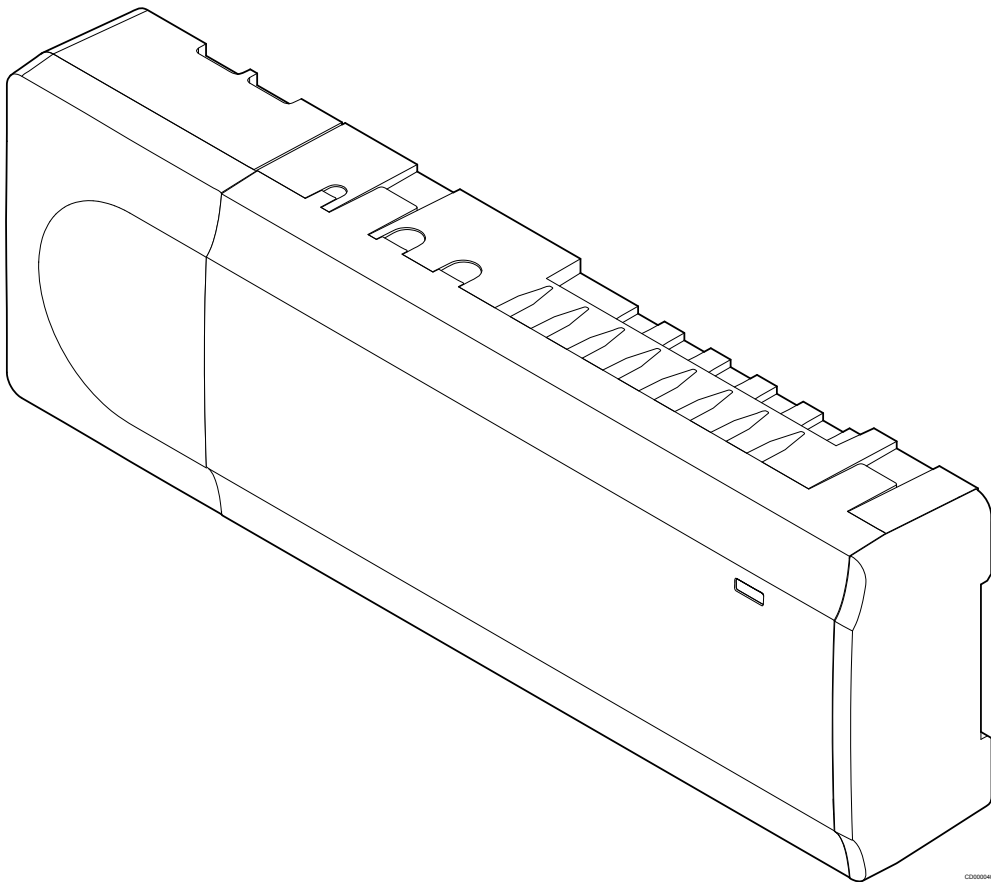



# Table of contents

<b>1</b>	<b>Installation.....</b>	<b>3</b>
1.1	General.....	3
1.2	Preparation.....	3
1.3	Connecting to the BMS cable.....	4
1.4	Modbus RTU settings.....	5
1.5	Cabling and topology.....	5
1.6	Channel allocation.....	5
1.7	Installation example, Modbus RTU.....	5
<b>2</b>	<b>Supported Modbus RTU functions.....</b>	<b>6</b>
2.1	Frame format: Read Coil.....	6
2.2	Frame format: Read Discrete Input.....	7
2.3	Frame format: Read Holding Registers.....	8
2.4	Frame format: Read Input Registers.....	9
2.5	Frame format: Write Single Coil.....	11
2.6	Frame format: Write Single Holding Register.....	11
2.7	Frame format: Write Multiple Coils.....	13
2.8	Frame format: Write Multiple Holding Registers.....	13
<b>3</b>	<b>Available variables.....</b>	<b>15</b>
3.1	Temperature conversion.....	15
3.2	Controller limitations.....	15
3.3	Coil data points.....	16
3.4	Discrete Input data points.....	19
3.5	Input Register data points.....	21
3.6	Holding Register data points.....	22
<b>4</b>	<b>Troubleshooting.....</b>	<b>29</b>
4.1	No communication between controller and BMS.....	29
4.2	Slow communication, or high latency, between Uponor system and BMS.....	29
4.3	Wrong parameters changed in Uponor system compared to BMS settings.....	29

# 1 Installation

## 1.1 General

	<p><b>Caution!</b></p> <p>Send all settings from BMS, such as set points, limits, override etc. cyclically. Max 30 minutes interval time is recommended.</p>
	<p><b>Note</b></p> <p>Basic knowledge and training on BMS and Modbus RTU is required for installation and setup of Base PRO with Modbus RTU.</p>
	<p><b>Note</b></p> <p>General setup handling, such as thermostat registration, can be found in the Quick Guide for Uponor Smatrix Base PRO (X-147).</p>

The Uponor Smatrix Base PRO Controller X-148 Modbus RTU is preloaded with the correct software for connection and integration to a building management system (BMS) through a Modbus RTU connection over RS-485.

The BMS gets access to the following in the Base PRO system.

Read:





- Outdoor temperature
- Room temperature
- Floor temperature
- Humidity level
- Actuator status
- Pump or boiler status
- General purpose input (GPI) status
- Loss of thermostat connection
- Dynamic heat curve offset in integrated heat pump\*

Read and write:

- Room setpoint
- Min/max levels for setpoint
- Activation of setpoint override for analog thermostats
- Min/max levels for floor temperature
- Heating/Cooling state
- Heating/Cooling offset
- Comfort/ECO
- Autobalancing on/off
- Cooling not allowed for a room
- Comfort setting
- Integrated heat pump defrost state\*
- Relative humidity (RH) control

\* Requires **Heat Pump Integration via BMS** to be activated in U\_BMS.txt.

## 1.2 Preparation

	<p><b>Caution!</b></p> <p>If an Uponor Smatrix Base PRO Interface I-147 is connected, it must be unregistered and disconnected.</p>
	<p><b>Caution!</b></p> <p>Do not remove the microSD card while the controller is powered on.</p>
	<p><b>Caution!</b></p> <p>Be careful when editing the configuration in the U_BMS.txt file.</p> <p>Preferably use Notepad in Windows since other editors might add scrap and/or hidden characters to the file.</p>
	<p><b>Note</b></p> <p>Make sure that the thermostats are registered to consecutive channels so the BMS can read and write all channels in an efficient way. That is, addressing multiple channels in one message.</p>
	<p><b>Note</b></p> <p>Make sure the correct slave address is set (between 1 and 247, unique for each controller in the system), and that the other communication settings in the U_BMS.txt file match the Modbus RTU settings in the BMS.</p>

To connect a BMS to the Uponor Smatrix Base PRO controller some preparations must be made.

### 1. Connect and register thermostats and system device

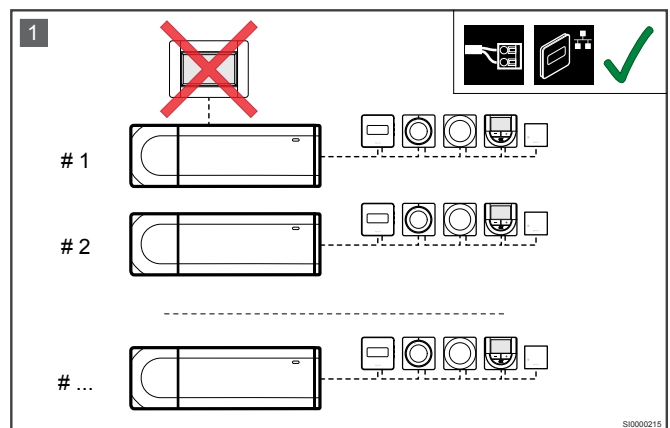

Connect and register thermostats, and system devices, to the controllers.

See *Uponor Smatrix Base PRO installation and operation manual, or quick guide, for information registering devices to the controller.*

### 2. Software

The controller X-148 Modbus RTU is preloaded with the correct software already when delivered.

### 3. Edit the U\_BMS.txt file

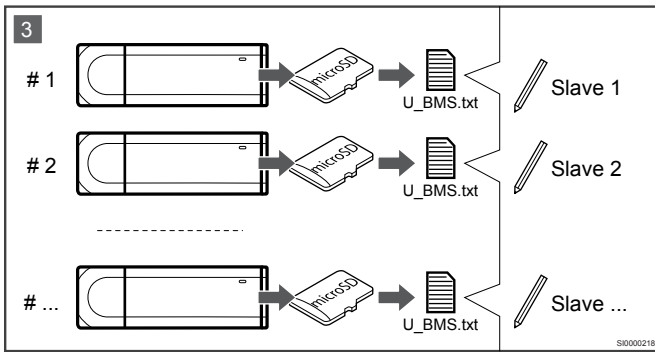

Edit the U\_BMS.txt file, on the controller microSD card, to setup the controller Modbus RTU interface.

Available settings (default in **bold**):

- BMS Slave address: **1** to 247
- BMS Baud rate: **19200** or 9600
- BMS Parity: **even**, odd, no (or none)
- Heat pump integration via BMS: **off** or on  
*on = enables dynamic heat curve offset in integrated heat pump, and integrated heat pump defrost state.*
- Exclude zone from heat curve offset calculation:  
**0**, or 1 through 12 (0 = no channel)  
*Select master channels of the zones (lowest numbered channel in the zone) to exclude.  
The zone subchannels follow the state of the master channel.  
Example: 3,5,12 = excludes channels with master channels 3, 5 and 12.*
- Bypass zone: **0**, or 1 to 12 (0 = no channel, example: 3,12)  
*Select master channels of the zones (lowest numbered channel in the zone) to bypass, MAXIMUM 2 channels.  
The zone subchannels follow the state of the master channel.  
Example: 4,12 = bypasses zones with master channels 4 and 12.*
- Ceiling cooling channel: **0**, or 1 to 12 (0 = no channel, example: 1,4,10)  
*Select the channels which controls ceiling cooling in the zones. The zone subchannels will not follow the state of the master channel.  
Example: 1,4,10 = set ceiling cooling to channels 1, 4 and 10.*
- BMS Temperature format: c or f  
c = Celsius, f = Fahrenheit

Repeat for each Base PRO controller in the system.

### 4. Connect the controllers

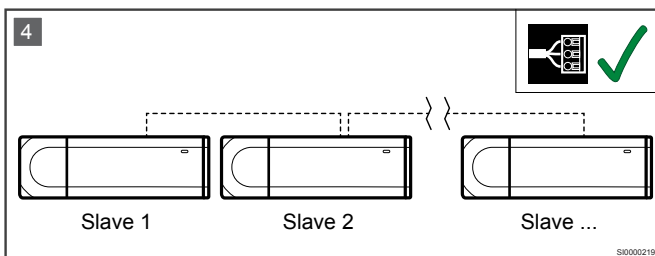

Connect the controllers to each other using the Base PRO controller system device bus.

### 5. Connect the Base PRO system

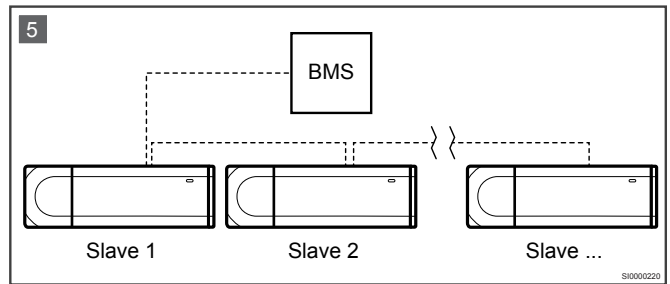

Connect the Base PRO system to the BMS.

## 1.3 Connecting to the BMS cable



#### Caution!

Depending on EMC conditions in the installation, and/or distance between the devices, the "-" connection on the Base PRO controller might be needed.

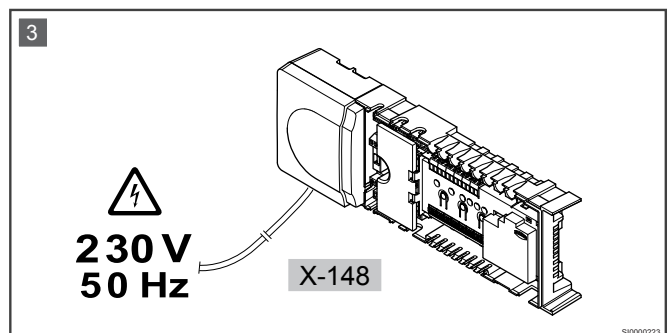
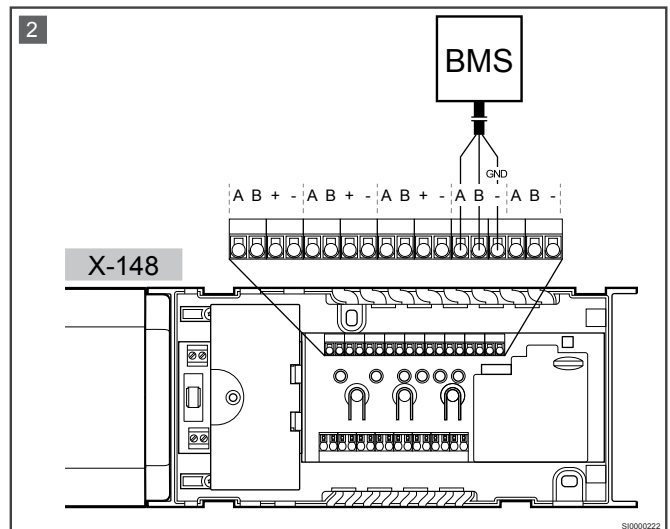
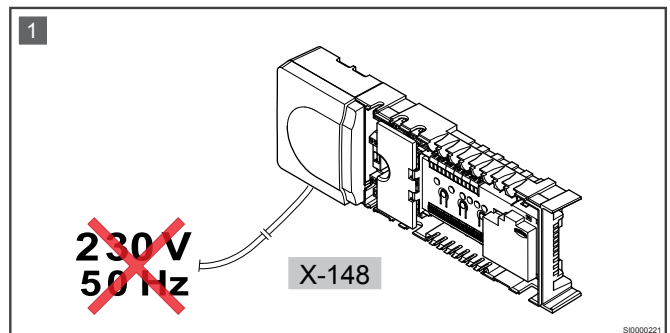

The illustrations above show how to connect a BMS to the Modbus RTU interface on the controller.

To connect a BMS to the controller:

1. Ensure that the power is disconnected from the controller.
2. Connect the BMS cable to the Base PRO controller system device bus.  
Study the wiring diagrams of the controller to locate the connector position.
3. Connect power to the controller again.



See documentation from BMS supplier for more information about BMS integration.

## 1.4 Modbus RTU settings

Configure the Modbus RTU interface in the BMS to match the controller settings:

- Baudrate: 19200 or 9600 bps
- Data bits: 8
- Stop bits: 1
- Parity bit: even, odd, no (or none)
- Flow control: No

## 1.5 Cabling and topology

	<b>Caution!</b>
	Be thorough about the cabling and connections. Only use Uponor recommended cables and go for a line bus topology.
	<b>Caution!</b>
	Be prepared to add 120 ohm termination resistors between "A" and "B" on end devices, if the total bus length goes over 250 m or if any communication problems are noticed.
	<b>Caution!</b>
	Always connect also the "-" between the controllers on the global bus and to the BMS.

## 1.6 Channel allocation

	<b>Note</b>
	For multiple channel rooms, only operate on the first channel, i.e. the master channel.

## 1.7 Installation example, Modbus RTU

	<b>Caution!</b>
	The Uponor Smatrix Base PRO Interface I-147 cannot be used in Modbus RTU installations.

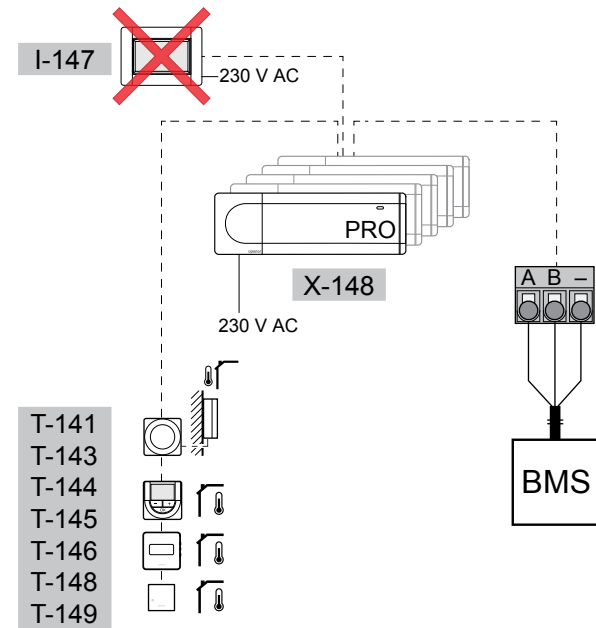

50000033

# 2 Supported Modbus RTU functions

The Base PRO controller supports the following functions for Modbus RTU communication.

Description	Function code (hex)
Read Coil	0x01
Read Discrete Input	0x02
Read Holding Registers	0x03
Read Input Registers	0x04
Write Single Coil	0x05
Write Single Holding Register	0x06
Write Multiple Coils	0x0F
Write Multiple Holding Registers	0x10

- Discrete Inputs (read only) and Coils (read and write) are function codes consisting of 1 bit of data. Most often on or off.
- Input Registers (read only) and Holding Registers (read and write) are function codes consisting of 2 bytes (16 bit) of data. Most often temperature data or settings.

## 2.1 Frame format: Read Coil

Request				
Slave address	Function code	Starting register address	Number of coils to read	CRC
(0x01 – 0xF7)	(0x01)	(0x0000 – 0xFFFF)	(1 – 2000)	
1 byte	1 byte	2 bytes	2 bytes	2 bytes

Response				
Slave address	Function code	Byte count	Coil status	CRC
(0x01 – 0xF7)	(0x01)	(N)	(n = N, or n=N+1 if the number of coils to read can be divided by 8 with a remainder separated from 0)	
1 byte	1 byte	1 byte	n bytes	2 bytes

Response in case of error				
Slave address	Error code	Exception code		CRC
(0x01 – 0xF7)	(0x81)	(01, 02, 03, 04, or 06)		
1 byte	1 byte	1 byte		2 bytes

### Example:

Request example: Read Heating/Cooling and Comfort/ECO states						
Slave address	Function code	Starting register address HI	Starting register address LO	Number of coils to read HI	Number of coils to read LO	CRC
(0x01)	(0x01)	(0x00)	(0x00)	(0x00)	(0x02)	
1 byte	1 byte	1 byte	1 byte	1 byte	1 byte	2 bytes

Response example: Read Heating/Cooling and Comfort/ECO states				
Slave address	Function code	Byte count	Coil status	CRC
(0x01)	(0x01)	(0x01)	1 to 8 (0x02)	
1 byte	1 byte	1 byte	1 byte	2 bytes

## 2.2 Frame format: Read Discrete Input

Request					
Slave address	Function code	Starting register address		Number of coils to read	CRC
(0x01 – 0xF7)	(0x02)	(0x0000 – 0xFFFF)		(1 – 2000)	
1 byte	1 byte	2 bytes		2 bytes	2 bytes

Response					
Slave address	Function code	Byte count		Coil status	CRC
(0x01 – 0xF7)	(0x02)	(N)		(n = N, or n=N+1 if the number of coils to read can be divided by 8 with a remainder separated from 0)	
1 byte	1 byte	1 byte		n bytes	2 bytes

Response in case of error					
Slave address	Error code	Exception code			CRC
(0x01 – 0xF7)	(0x82)	(01, 02, 03, 04, or 06)			
1 byte	1 byte	1 byte			2 bytes

### Example:

Request example: Read all discrete inputs						
Slave address	Function code	Starting register address HI	Starting register address LO	Number of coils to read HI	Number of coils to read LO	CRC
(0x01)	(0x02)	(0x00)	(0x00)	(0x00)	14 bits (0x0E)	
1 byte	1 byte	1 byte	1 byte	1 byte	1 byte	2 bytes

Response example: Read all discrete inputs						
Slave address	Function code	Byte count		Coil status 1 to 8	Coil status 9 to 16	CRC
(0x01)	(0x02)	(0x02)		(0xAA)	(0x0A)	
1 byte	1 byte	2 bytes		1 byte	1 byte	2 bytes

Request example: Read actuator status, channel 12						
Slave address	Function code	Starting register address HI	Starting register address LO	Number of coils to read HI	Number of coils to read LO	CRC
(0x01)	(0x02)	(0x00)	Register 12 (0x0B)	(0x00)	1 bit (0x01)	
1 byte	1 byte	1 byte	1 byte	1 byte	1 byte	2 bytes

Response example: Read actuator status, channel 12					
Slave address	Function code	Byte count		Coil status channel 12	CRC
(0x01)	(0x02)	(0x01)		ON (0x01)	
1 byte	1 byte	1 byte		1 byte	2 bytes

Request example: Read actuator status, all channels						
Slave address	Function code	Starting register address HI	Starting register address LO	Number of coils to read HI	Number of coils to read LO	CRC
(0x01)	(0x02)	(0x00)	(0x00)	(0x00)	12 bits (0x0C)	
1 byte	1 byte	1 byte	1 byte	1 byte	1 byte	2 bytes

Response example: Read actuator status, all channels						
Slave address	Function code	Byte count		Coil status 1 to 8	Coil status 9 to 12	CRC
(0x01)	(0x02)	(0x02)		(0xAA)	(0x0A)	
1 byte	1 byte	2 bytes		1 byte	1 byte	2 bytes

## 2.3 Frame format: Read Holding Registers

Request				
Slave address	Function code	Starting register address	Quantity of holding registers to read	CRC
(0x01 – 0xF7)	(0x03)	(0x0000 – 0xFFFF)	(0x0001 – 0x007D)	
1 byte	1 byte	2 bytes	2 bytes	2 bytes

Response				
Slave address	Function code	Byte count	Holding register	CRC
(0x01 – 0xF7)	(0x03)	(2*N) N = quantity of registers		
1 byte	1 byte	1 byte	2*N bytes	2 bytes

Response in case of error				
Slave address	Error code	Exception code		CRC
(0x01 – 0xF7)	(0x83)	(01, 02, 03, 04, or 06)		
1 byte	1 byte	1 byte		2 bytes

### Example:

Request example: Read setpoints (21.0 °C / 69.8 °F = value 689, 0x02BA), 12 channels						
Slave address	Function code	Starting register address HI	Starting register address LO	Quantity of holding registers to read HI	Quantity of holding registers to read LO	CRC
(0x01)	(0x03)	(0x00)	Start at 1 (0x00)	(0x00)	12 channels (0x0C)	
1 byte	1 byte	1 byte	1 byte	1 byte	1 byte	2 bytes

Response example: Read setpoints (21.0 °C / 69.8 °F = value 689, 0x02BA), 12 channels								
Slave address	Function code	Byte count	Holding register HI (channel 1)	Holding register LO (channel 1)	...	Holding register HI (channel 12)	Holding register LO (channel 12)	CRC
(0x01)	(0x03)	(0x18)	(0x02)	(0xBA)		(0x02)	(0xBA)	
1 byte	1 byte	1 byte	1 byte	1 byte	...	1 byte	1 byte	2 bytes

Request example: Read setpoint (21.0 °C / 69.8 °F = value 689, 0x02BA), channel 10						
Slave address	Function code	Starting register address HI	Starting register address LO	Quantity of holding registers to read HI	Quantity of holding registers to read LO	CRC
(0x01)	(0x03)	(0x00)	Start at 10 (0x09)	(0x00)	1 channel (0x01)	
1 byte	1 byte	1 byte	1 byte	1 byte	1 byte	2 bytes

Response example: Read setpoint (21.0 °C / 69.8 °F = value 689, 0x02BA), channel 10					
Slave address	Function code	Byte count	Holding register HI	Holding register LO	CRC
(0x01)	(0x03)	(0x02)	(0x02)	(0xBA)	
1 byte	1 byte	1 byte	1 byte	1 byte	2 bytes

Request example: Read comfort setting, channel 12						
Slave address	Function code	Starting register address HI	Starting register address LO	Quantity of holding registers to read HI	Quantity of holding registers to read LO	CRC
(0x01)	(0x03)	(0x00)	Start at 72 (0x47)	(0x00)	1 channel (0x01)	
1 byte	1 byte	1 byte	1 byte	1 byte	1 byte	2 bytes

Response example: Read comfort setting, channel 12					
Slave address	Function code	Byte count	Holding register HI	Holding register LO	CRC
(0x01)	(0x03)	(0x02)	(0x02)	(0xBA)	
1 byte	1 byte	1 byte	1 byte	1 byte	2 bytes



Request example: Read heating/cooling offset temperature						
Slave address (0x01)	Function code (0x03)	Starting register address HI (0x00)	Starting register address LO Start at 73 (0x48)	Quantity of holding registers to read HI (0x00)	Quantity of holding registers to read LO (0x01)	CRC
1 byte	1 byte	1 byte	1 byte	1 byte	1 byte	2 bytes

Response example: Read heating/cooling offset temperature						
Slave address (0x01)	Function code (0x03)	Byte count (0x02)	Holding register HI (0x02)	Holding register LO 2 °C (0x24)		CRC
1 byte	1 byte	1 byte	1 byte	1 byte		2 bytes

## 2.4 Frame format: Read Input Registers

Request					
Slave address (0x01 – 0xF7)	Function code (0x04)	Starting register address (0x0000 – 0xFFFF)		Quantity of holding registers to read (0x0001 – 0x007D)	CRC
1 byte	1 byte	2 bytes		2 bytes	2 bytes

Response					
Slave address (0x01 – 0xF7)	Function code (0x04)	Byte count (2*N) N = quantity of registers		Input register 2*N bytes	CRC
1 byte	1 byte	1 byte		2*N bytes	2 bytes

Response in case of error					
Slave address (0x01 – 0xF7)	Error code (0x84)	Exception code (01, 02, 03, 04, or 06)			CRC
1 byte	1 byte	1 byte			2 bytes

### Example:

Request example: Read room temperature data (21.0 °C / 69.8 °F = value 689, 0x02BA) for all zones						
Slave address (0x01)	Function code (0x04)	Starting register address HI (0x00)	Starting register address LO Start at 2 (0x01)	Quantity of input registers to read HI (0x00)	Quantity of input registers to read LO 12 channels (0x0C)	CRC
1 byte	1 byte	1 byte	1 byte	1 byte	1 byte	2 bytes

Response example: Read room temperature data (21.0 °C / 69.8 °F = value 689, 0x02BA) for all zones								
Slave address (0x01)	Function code (0x04)	Byte count (0x18)	Input register HI (channel 1) (0x02)	Input register LO (channel 1) (0xBA)	...	Input register HI (channel 12) (0x02)	Input register LO (channel 12) (0xBA)	CRC
1 byte	1 byte	1 byte	1 byte	1 byte	...	1 byte	1 byte	2 bytes

Request example:Read floor temperature data (21.0 °C / 69.8 °F = value 689, 0x02BA) for all zones						
Slave address (0x01)	Function code (0x04)	Starting register address HI (0x00)	Starting register address LO Start at 26 (0x19)	Quantity of input registers to read HI (0x00)	Quantity of input registers to read LO 12 channels (0x0C)	CRC
1 byte	1 byte	1 byte	1 byte	1 byte	1 byte	2 bytes

Response example:Read floor temperature data (21.0 °C / 69.8 °F = value 689, 0x02BA) for all zones								
Slave address (0x01)	Function code (0x04)	Byte count (0x18)	Input register HI (channel 1) (0x02)	Input register LO (channel 1) (0xBA)	...	Input register HI (channel 12) (0x02)	Input register LO (channel 12) (0xBA)	CRC
1 byte	1 byte	1 byte	1 byte	1 byte	...	1 byte	1 byte	2 bytes

Request example:Read humidity value (85% RH) for channel 12						
Slave address (0x01)	Function code (0x04)	Starting register address HI (0x00)	Starting register address LO Start at 25 (0x18)	Quantity of input registers to read HI (0x00)	Quantity of input registers to read LO 1 channel (0x01)	CRC
1 byte	1 byte	1 byte	1 byte	1 byte	1 byte	2 bytes

Response example:Read humidity value (85% RH) for channel 12						
Slave address (0x01)	Function code (0x04)	Byte count (0x02)	Input register HI (0x00)	Input register LO (0x55)		CRC
1 byte	1 byte	1 byte	1 byte	1 byte		2 bytes

Request example:Read thermostat loss alarm						
Slave address (0x01)	Function code (0x04)	Starting register address HI (0x00)	Starting register address LO Start at 38 (0x25)	Quantity of input registers to read HI (0x00)	Quantity of input registers to read LO (0x01)	CRC
1 byte	1 byte	1 byte	1 byte	1 byte	1 byte	2 bytes

Response example:Read thermostat loss alarm						
Slave address (0x01)	Function code (0x04)	Byte count (0x02)	Input register HI (0x08)	Input register LO (0x01)		CRC
1 byte	1 byte	1 byte	1 byte	1 byte		2 bytes

Request example:Offset heat pump heat curve with -10 degrees						
Slave address (0x01)	Function code (0x04)	Starting register address HI (0x00)	Starting register address LO Start at 39 (0x26)	Quantity of input registers to read HI (0x00)	Quantity of input registers to read LO (0x01)	CRC
1 byte	1 byte	1 byte	1 byte	1 byte	1 byte	2 bytes

Response example:Offset heat pump heat curve with -10 degrees						
Slave address (0x01)	Function code (0x04)	Byte count (0x02)	Input register HI (0x00)	Input register LO (0xF6)		CRC
1 byte	1 byte	1 byte	1 byte	1 byte		2 bytes

## 2.5 Frame format: Write Single Coil

Request				
Slave address	Function code	Starting register address	Output value to write	CRC
(0x01 – 0xF7)	(0x05)	(0x0000 – 0xFFFF)	(0xFF00 = 1, 0x0000 = 0)	
1 byte	1 byte	2 bytes	2 bytes	2 bytes

Response				
Slave address	Function code	Output address to write	Output value written	CRC
(0x01 – 0xF7)	(0x05)	(0x0000 – 0xFFFF)	(0xFF00 = 1, 0x0000 = 0)	
1 byte	1 byte	2 bytes	2 bytes	2 bytes

Response in case of error				
Slave address	Error code	Exception code		CRC
(0x01 – 0xF7)	(0x85)	(01, 02, 03, 04, or 06)		
1 byte	1 byte	1 byte		2 bytes

### Example:

Request example: Change state from ECO to Comfort						
Slave address	Function code	Starting register address HI	Starting register address LO	Output value to write HI	Output value to write LO	CRC
(0x01)	(0x05)	(0x00)	Register 2 (0x01)	(0x00)	(0x00)	
1 byte	1 byte	1 byte	1 byte	1 byte	1 byte	2 bytes

Response example: Change state from ECO to Comfort						
Slave address	Function code	Output address to write HI	Output address to write LO	Output value written HI	Output value written LO	CRC
(0x01)	(0x05)	(0x00)	Register 2 (0x01)	(0x00)	(0x00)	
1 byte	1 byte	1 byte	1 byte	1 byte	1 byte	2 bytes

## 2.6 Frame format: Write Single Holding Register

Request				
Slave address	Function code	Starting register address	Register value	CRC
(0x01 – 0xF7)	(0x06)	(0x0000 – 0xFFFF)	(0x0000 – 0xFFFF)	
1 byte	1 byte	2 bytes	2 bytes	2 bytes

Response				
Slave address	Function code	Output address to write	Output value written	CRC
(0x01 – 0xF7)	(0x06)	(0x0000 – 0xFFFF)	(0x0000 – 0xFFFF)	
1 byte	1 byte	2 bytes	2 bytes	2 bytes

Response in case of error				
Slave address	Error code	Exception code		CRC
(0x01 – 0xF7)	(0x86)	(01, 02, 03, 04, or 06)		
1 byte	1 byte	1 byte		2 bytes

## Examples:

Request example: Write 23 °C (73.4 °F = value 734, 0x02DE) setpoint, channel 5						
Slave address (0x01)	Function code (0x06)	Starting register address HI (0x00)	Starting register address LO Start at 5 (0x04)	Register value HI (0x02)	Register value LO (0x0E)	CRC
1 byte	1 byte	1 byte	1 byte	1 byte	1 byte	2 bytes

Response example: Write 23 °C (73.4 °F = value 734, 0x02DE) setpoint, channel 5						
Slave address (0x01)	Function code (0x06)	Output address to write HI (0x00)	Output address to write LO Start at 5 (0x04)	Output value written HI (0x02)	Output value written LO (0x0E)	CRC
1 byte	1 byte	1 byte	1 byte	1 byte	1 byte	2 bytes

Request example: Write 25 °C (77.0 °F = value 770, 0x0302) maximum floor temperature limit, channel 12						
Slave address (0x01)	Function code (0x06)	Starting register address HI (0x00)	Starting register address LO Start at 59 (0x3A)	Register value HI (0x03)	Register value LO (0x02)	CRC
1 byte	1 byte	1 byte	1 byte	1 byte	1 byte	2 bytes

Response example: Write 25 °C (77.0 °F = value 770, 0x0302) maximum floor temperature limit, channel 12						
Slave address (0x01)	Function code (0x06)	Output address to write HI (0x00)	Output address to write LO Start at 59 (0x3A)	Output value written HI (0x03)	Output value written LO (0x02)	CRC
1 byte	1 byte	1 byte	1 byte	1 byte	1 byte	2 bytes

Request example: Write 12 % comfort setting, channel 12						
Slave address (0x01)	Function code (0x06)	Starting register address HI (0x00)	Starting register address LO Start at 72 (0x47)	Register value HI (0x00)	Register value LO (0x0C)	CRC
1 byte	1 byte	1 byte	1 byte	1 byte	1 byte	2 bytes

Response example: Write 12 % comfort setting, channel 12						
Slave address (0x01)	Function code (0x06)	Output address to write HI (0x00)	Output address to write LO Start at 72 (0x47)	Output value written HI (0x00)	Output value written LO (0x0C)	CRC
1 byte	1 byte	1 byte	1 byte	1 byte	1 byte	2 bytes

Request example: Write 5 °C (41.0 °F = value 410, 0x005A) heating/cooling offset temperature						
Slave address (0x01)	Function code (0x06)	Starting register address HI (0x00)	Starting register address LO Start at 73 (0x48)	Register value HI (0x00)	Register value LO (0x5A)	CRC
1 byte	1 byte	1 byte	1 byte	1 byte	1 byte	2 bytes

Response example: Write 5 °C (41.0 °F = value 410, 0x005A) heating/cooling offset temperature						
Slave address (0x01)	Function code (0x06)	Output address to write HI (0x00)	Output address to write LO Start at 73 (0x48)	Output value written HI (0x00)	Output value written LO (0x5A)	CRC
1 byte	1 byte	1 byte	1 byte	1 byte	1 byte	2 bytes

## 2.7 Frame format: Write Multiple Coils

Request						
Slave address (0x01 – 0xF7)	Function code (0x0F)	Starting register address (0x0000 – 0xFFFF)	Quantity of outputs (0x0001 – 0x07B0)	Byte count (N)	Output value to write	CRC
1 byte	1 byte	2 bytes	2 bytes	1 byte	n bytes	2 bytes

Response					
Slave address (0x01 – 0xF7)	Function code (0x0F)	Starting register address (0x0000 – 0xFFFF)	Quantity of outputs (0x0001 – 0x07B0)		CRC
1 byte	1 byte	2 bytes	2 bytes		2 bytes

Response in case of error				
Slave address (0x01 – 0xF7)	Error code (0x8F)	Exception code (01, 02, 03, 04, or 06)		CRC
1 byte	1 byte	1 byte		2 bytes

### Example:

Request example: Changes states to Cooling and ECO								
Slave address (0x01)	Function code (0x0F)	Starting register address HI (0x00)	Starting register address LO (0x00)	Quantity of outputs HI (0x00)	Quantity of outputs LO (0x02)	Byte count (0x01)	Output value to write (0x03)	CRC
1 byte	1 byte	1 byte	1 byte	1 byte	1 byte	1 byte	? byte	2 bytes

Response example: Changes states to Cooling and ECO							
Slave address (0x01)	Function code (0x0F)	Starting register address HI (0x00)	Starting register address LO (0x00)	Quantity of outputs HI (0x00)	Quantity of outputs LO (0x02)		CRC
1 byte	1 byte	1 byte	1 byte	1 byte	1 byte		2 bytes

## 2.8 Frame format: Write Multiple Holding Registers

Request						
Slave address (0x01 – 0xF7)	Function code (0x10)	Starting register address (0x0000 – 0xFFFF)	Quantity of registers (0x0000 – 0x007B)	Byte count (2*N) N = quantity of registers	Register value	CRC
1 byte	1 byte	2 bytes	2 bytes	1 byte	2*N bytes	2 bytes

Response				
Slave address (0x01 – 0xF7)	Function code (0x10)	Starting register address (0x0000 – 0xFFFF)	Quantity of registers written (0x0000 – 0x007B)	CRC
1 byte	1 byte	2 bytes	2 bytes	2 bytes

Response in case of error			
Slave address (0x01 – 0xF7)	Error code (0x90)	Exception code (01, 02, 03, 04, or 06)	CRC
1 byte	1 byte	1 byte	2 bytes

## Example:

<b>Request example: Write 23 °C (73.4 °F = value 734, 0x02DE) maximum setpoint limit and 18 °C (64.4 °F = value 644, 0x0284) minimum setpoint limit, channel 5</b>											
Slave address	Function code	Starting register address HI	Starting register address LO	Quantity of registers HI	Quantity of registers LO	Byte count (0x04)	Register 21 value HI	Register 21 value LO	Register 22 value HI	Register 22 value LO	CRC
(0x01)	(0x10)	(0x00)	Start at 21 (0x14)	(0x00)	(0x02)		(0x02)	(0xDE)	(0x02)	(0x84)	
1 byte	1 byte	1 byte	1 byte	1 byte	1 byte	1 byte	1 byte	1 byte	1 byte	1 byte	2 bytes

<b>Response example: Write 23 °C (73.4 °F = value 734, 0x02DE) maximum setpoint limit and 18 °C (64.4 °F = value 644, 0x0284) minimum setpoint limit, channel 5</b>							
Slave address	Function code	Starting register address HI	Starting register address LO	Quantity of outputs HI	Quantity of outputs LO	CRC	
(0x01)	(0x10)	(0x00)	(0x00)	(0x00)	(0x02)		
1 byte	1 byte	1 byte	1 byte	1 byte	1 byte	2 bytes	

# 3 Available variables

These variables are available when communicating with the Base PRO controller (with the Modbus RTU compatible software installed).

## 3.1 Temperature conversion

**Note**

If no data value is available the Celsius value is set to 1802.6.

The Uponor Smatrix Base PRO controller uses Fahrenheit (default) to read and calculate temperatures. The temperature format can be changed in the U\_BMS.txt file.

To convert the data value into Celsius, use the following mathematical formula.

$$\text{Celsius} = ((\text{data value} - 320)/1.8)/10$$

### Temperature (absolute value)

Celsius (°C)	Fahrenheit (°F)	Data value	Hex value
-40.0	-40.0	-400	0xFE70
-30.0	-22.0	-220	0xFF24
-20.0	-4.0	-40	0xFFD8
-17.8	0.0	0	0x0
-10.0	14.0	140	0x8C
-5.0	23.0	230	0xE6
0.0	32.0	320	0x140
1.0	33.8	338	0x152
5.0	41.0	410	0x19A
10.0	50.0	500	0x1F4
15.0	59.0	590	0x24E
18.0	64.4	644	0x284
20.0	68.0	680	0x2A8
21.0	69.8	698	0x2BA
25.0	77.0	770	0x302
30.0	86.0	860	0x35C
35.0	95.0	950	0x3B6
40.0	104.0	1040	0x410

### Temperature (relative value)

Celsius (°C)	Data value	Hex value
0.1	2	0x02
1.0	18	0x13
4.0	72	0x48
5.0	90	0x5A

## Humidity (absolute value)

Relative humidity (%)	Hex value
0	0x0000
5	0x0005
10	0x000A
15	0x000F
20	0x0014
25	0x0019
30	0x001E
35	0x0023
40	0x0028
45	0x002D
50	0x0032
55	0x0037
60	0x003C
65	0x0041
70	0x0046
75	0x004B
80	0x0050
85	0x0055
90	0x005A
95	0x005F
100	0x0064

## 3.2 Controller limitations

### Cooling state

An ordinary Base PRO system (with touch screen, not connected to a BMS) uses an offset temperature to adjust the setpoints when switching between heating and cooling. This setting is only available via the touch screen interface (I-167), which is not installed when connected to a BMS.

When connected to a BMS, and the heating/cooling state is set to cooling, the cooling offset is set to 0 °C (0 °F), leaving the zone setpoints to be changed by the BMS.

### ECO state

If the Base PRO system is set to ECO state the controller applies an ECO setback value of 4 °C (4 °F) to the setpoints (which is shown in the thermostats).

When the BMS reads the setpoint, when in ECO state, it will receive the actual setpoint (without the ECO setback value applied).

Example	
Setpoint written/read from BMS	21 °C (69.8 °F)
Comfort/ECO state	1 (ECO)
Setpoint shown in thermostat	17 °C (62.6 °F)

## Zones

	<b>Caution!</b>
	When writing to a channel, address the lowest channel number (master channel) in the zone (if more than one channel in the zone) in order to change the value/state for the whole zone.

The Base PRO controller can control a maximum of 6 actuator channels, 12 if a slave module is installed. These channels are then divided into zones which are linked to a thermostat.

A zone can consist of 1 to 12 channels, and not all channels must be connected to an actuator and linked to a thermostat.

## Comfort setting

The Base PRO can set a basic level of comfort for a zone when there is no demand for heating. The value set is the percentage of time the actuators are opened.

It will shorten the heat up time for the room, which is useful in rooms where other heating sources, e.g. a fireplace, is present.

When the BMS reads the comfort setting it will receive the actual percentage.

## Max/min limitations

If the BMS writes a setpoint to a zone, the Base PRO controller applies maximum and minimum limitations before checking if there is a demand for heating or cooling. The limited setpoint is also shown on the thermostat.

The maximum and minimum limitations are also affected whether the controller is set to Comfort or ECO state.

When the BMS reads the setpoint it will receive the actual setpoint (without limitation applied).

Example	
Setpoint written/read from BMS	28 °C (82.4 °F)
Room setpoint max temperature	25 °C (77 °F)
Room setpoint min temperature	15 °C (59 °F)
Setpoint in room thermostat	25 °C (77 °F)
Comfort/ECO state	0 (Comfort)
Room temperature	20 °C (68 °F)
Heating demand	YES

## Dynamic heat curve offset in integrated heat pump

	<b>Caution!</b>
	The heat pump must be connected to the BMS. Do not use the heat pump integration connectors on the Base PRO controller.

	<b>Note</b>
	This function requires <b>Heat pump integration via BMS</b> set to <b>on</b> on the microSD card to be activated.

The Base PRO system can dynamically adjust the heat curve offset in a BMS integrated heat pump. The BMS reads the value from the controller and sends it to the heat pump.

The heat curve can be offset between -10 °C and +10 °C (-10 °F and +10 °F).

When the BMS reads the heat curve offset from the controller it will receive an absolute degree value to offset the heat curve in the heat pump.

## 3.3 Coil data points

	<b>Note</b>
	1 = 0xFF00
	0 = 0x0000

These datapoints can be both read or written, and contains the status of different controller settings (binary, on/off).

Display name	Register address (decimal)	Physical address (decimal)	Function code (Hex)	Type	Analogue/ Binary	Coding
Heating/Cooling state	00001	00000	0x01	Read	Binary	Unsigned. 1 = Cooling, 0 = Heating (default)
			0x05	Write		
			0x0F	Write multiple		
Comfort/ECO state	00002	00001	0x01	Read	Binary	Unsigned. 1 = Cooling, 0 = Heating (default)
			0x05	Write		
			0x0F	Write multiple		
Auto balancing on/off	00003	00002	0x01	Read	Binary	Unsigned.



Display name	Register address (decimal)	Physical address (decimal)	Function code (Hex)	Type	Analogue/ Binary	Coding
			0x05	Write		1 = ON (default), 0 = Off
			0x0F	Write multiple		
Cooling not allowed, channel 1	00004	00003	0x01	Read	Binary	Unsigned.
			0x05	Write		0 = Cooling not allowed
			0x0F	Write multiple		1 = Cooling allowed (default)
Cooling not allowed, channel 2	00005	00004	0x01	Read	Binary	Unsigned.
			0x05	Write		0 = Cooling not allowed
			0x0F	Write multiple		1 = Cooling allowed (default)
Cooling not allowed, channel 3	00006	00005	0x01	Read	Binary	Unsigned.
			0x05	Write		0 = Cooling not allowed
			0x0F	Write multiple		1 = Cooling allowed (default)
Cooling not allowed, channel 4	00007	00006	0x01	Read	Binary	Unsigned.
			0x05	Write		0 = Cooling not allowed
			0x0F	Write multiple		1 = Cooling allowed (default)
Cooling not allowed, channel 5	00008	00007	0x01	Read	Binary	Unsigned.
			0x05	Write		0 = Cooling not allowed
			0x0F	Write multiple		1 = Cooling allowed (default)
Cooling not allowed, channel 6	00009	00008	0x01	Read	Binary	Unsigned.
			0x05	Write		0 = Cooling not allowed
			0x0F	Write multiple		1 = Cooling allowed (default)
Cooling not allowed, channel 7	00010	00009	0x01	Read	Binary	Unsigned.
			0x05	Write		0 = Cooling not allowed
			0x0F	Write multiple		1 = Cooling allowed (default)
Cooling not allowed, channel 8	00011	00010	0x01	Read	Binary	Unsigned.
			0x05	Write		0 = Cooling not allowed
			0x0F	Write multiple		1 = Cooling allowed (default)
Cooling not allowed, channel 9	00012	00011	0x01	Read	Binary	Unsigned.
			0x05	Write		0 = Cooling not allowed
			0x0F	Write multiple		1 = Cooling allowed (default)
Cooling not allowed, channel 10	00013	00012	0x01	Read	Binary	Unsigned.
			0x05	Write		0 = Cooling not allowed
			0x0F	Write multiple		1 = Cooling allowed (default)
Cooling not allowed, channel 11	00014	00013	0x01	Read	Binary	Unsigned.
			0x05	Write		0 = Cooling not allowed
			0x0F	Write multiple		1 = Cooling allowed (default)
Cooling not allowed, channel 12	00015	00014	0x01	Read	Binary	Unsigned.
			0x05	Write		0 = Cooling not allowed
			0x0F	Write multiple		1 = Cooling allowed (default)
Integrated heat pump defrost state*	00016	00015	0x01	Read	Binary	Unsigned.
			0x05	Write		0 = Heat pump defrost off/stopped (default)
			0x0F	Write multiple		1 = Heat pump defrost started
Relative humidity (RH) control	00017	00016	0x01	Read	Binary	Unsigned.
			0x05	Write		0 = System RH control disabled (default)
			0x0F	Write multiple		1 = System RH control enabled

Display name	Register address (decimal)	Physical address (decimal)	Function code (Hex)	Type	Analogue/ Binary	Coding
Relative humidity (RH) control, channel 1	00018	00017	0x01	Read	Binary	Unsigned. 0 = RH control disabled (default) 1 = RH control enabled
			0x05	Write		
			0x0F	Write multiple		
Relative humidity (RH) control, channel 2	00019	00018	0x01	Read	Binary	Unsigned. 0 = RH control disabled (default) 1 = RH control enabled
			0x05	Write		
			0x0F	Write multiple		
Relative humidity (RH) control, channel 3	00020	00019	0x01	Read	Binary	Unsigned. 0 = RH control disabled (default) 1 = RH control enabled
			0x05	Write		
			0x0F	Write multiple		
Relative humidity (RH) control, channel 4	00021	00020	0x01	Read	Binary	Unsigned. 0 = RH control disabled (default) 1 = RH control enabled
			0x05	Write		
			0x0F	Write multiple		
Relative humidity (RH) control, channel 5	00022	00021	0x01	Read	Binary	Unsigned. 0 = RH control disabled (default) 1 = RH control enabled
			0x05	Write		
			0x0F	Write multiple		
Relative humidity (RH) control, channel 6	00023	00022	0x01	Read	Binary	Unsigned. 0 = RH control disabled (default) 1 = RH control enabled
			0x05	Write		
			0x0F	Write multiple		
Relative humidity (RH) control, channel 7	00024	00023	0x01	Read	Binary	Unsigned. 0 = RH control disabled (default) 1 = RH control enabled
			0x05	Write		
			0x0F	Write multiple		
Relative humidity (RH) control, channel 8	00025	00024	0x01	Read	Binary	Unsigned. 0 = RH control disabled (default) 1 = RH control enabled
			0x05	Write		
			0x0F	Write multiple		
Relative humidity (RH) control, channel 9	00026	00025	0x01	Read	Binary	Unsigned. 0 = RH control disabled (default) 1 = RH control enabled
			0x05	Write		
			0x0F	Write multiple		
Relative humidity (RH) control, channel 10	00027	00026	0x01	Read	Binary	Unsigned. 0 = RH control disabled (default) 1 = RH control enabled
			0x05	Write		
			0x0F	Write multiple		
Relative humidity (RH) control, channel 11	00028	00027	0x01	Read	Binary	Unsigned. 0 = RH control disabled (default) 1 = RH control enabled
			0x05	Write		
			0x0F	Write multiple		
Relative humidity (RH) control, channel 12	00029	00028	0x01	Read	Binary	Unsigned. 0 = RH control disabled (default) 1 = RH control enabled
			0x05	Write		
			0x0F	Write multiple		
Room setpoint override, channel 1	00030	00029	0x01	Read	Binary	Unsigned. 0 = Setpoint override disabled (default) 1 = Setpoint override enabled
			0x05	Write		
			0x0F	Write multiple		
Room setpoint override, channel 2	00031	00030	0x01	Read	Binary	Unsigned. 0 = Setpoint override disabled (default) 1 = Setpoint override enabled
			0x05	Write		
			0x0F	Write multiple		
Room setpoint override, channel 3	00032	00031	0x01	Read	Binary	Unsigned. 0 = Setpoint override disabled (default) 1 = Setpoint override enabled
			0x05	Write		
			0x0F	Write multiple		

Display name	Register address (decimal)	Physical address (decimal)	Function code (Hex)	Type	Analogue/ Binary	Coding
Room setpoint override, channel 4	00033	00032	0x01	Read	Binary	Unsigned. 0 = Setpoint override disabled (default) 1 = Setpoint override enabled
			0x05	Write		
			0x0F	Write multiple		
Room setpoint override, channel 5	00034	00033	0x01	Read	Binary	Unsigned. 0 = Setpoint override disabled (default) 1 = Setpoint override enabled
			0x05	Write		
			0x0F	Write multiple		
Room setpoint override, channel 6	00035	00034	0x01	Read	Binary	Unsigned. 0 = Setpoint override disabled (default) 1 = Setpoint override enabled
			0x05	Write		
			0x0F	Write multiple		
Room setpoint override, channel 7	00036	00035	0x01	Read	Binary	Unsigned. 0 = Setpoint override disabled (default) 1 = Setpoint override enabled
			0x05	Write		
			0x0F	Write multiple		
Room setpoint override, channel 8	00037	00036	0x01	Read	Binary	Unsigned. 0 = Setpoint override disabled (default) 1 = Setpoint override enabled
			0x05	Write		
			0x0F	Write multiple		
Room setpoint override, channel 9	00038	00037	0x01	Read	Binary	Unsigned. 0 = Setpoint override disabled (default) 1 = Setpoint override enabled
			0x05	Write		
			0x0F	Write multiple		
Room setpoint override, channel 10	00039	00038	0x01	Read	Binary	Unsigned. 0 = Setpoint override disabled (default) 1 = Setpoint override enabled
			0x05	Write		
			0x0F	Write multiple		
Room setpoint override, channel 11	00040	00039	0x01	Read	Binary	Unsigned. 0 = Setpoint override disabled (default) 1 = Setpoint override enabled
			0x05	Write		
			0x0F	Write multiple		
Room setpoint override, channel 12	00041	00040	0x01	Read	Binary	Unsigned. 0 = Setpoint override disabled (default) 1 = Setpoint override enabled
			0x05	Write		
			0x0F	Write multiple		

\* Requires **Heat Pump Integration via BMS** to be activated in U\_BMS.txt. It takes about 2 minutes for the actuators in the Base PRO system to be fully opened.



### 3.4 Discrete Input data points

These datapoints are read only and show the actuator, pump/boiler, and GPI status on the controller (binary, on/off).

Display name	Register address (decimal)	Physical address (decimal)	Function code (Hex)	Type	Analogue/ Binary	Coding
Actuator status/channel 1 (bit 0)	10001	10000	0x02	Read	Binary	Unsigned. 1 = ON, 0 = Off.
Actuator status/channel 2 (bit 1)	10002	10001	0x02	Read	Binary	Unsigned. 1 = ON, 0 = Off.
Actuator status/channel 3 (bit 2)	10003	10002	0x02	Read	Binary	Unsigned. 1 = ON, 0 = Off.
Actuator status/channel 4 (bit 3)	10004	10003	0x02	Read	Binary	Unsigned. 1 = ON, 0 = Off.
Actuator status/channel 5 (bit 4)	10005	10004	0x02	Read	Binary	Unsigned. 1 = ON, 0 = Off.
Actuator status/channel 6 (bit 5)	10006	10005	0x02	Read	Binary	Unsigned. 1 = ON, 0 = Off.
Actuator status/channel 7 (bit 6)	10007	10006	0x02	Read	Binary	Unsigned. 1 = ON, 0 = Off.

Display name	Register address (decimal)	Physical address (decimal)	Function code (Hex)	Type	Analogue/ Binary	Coding
Actuator status/channel 8 (bit 7)	10008	10007	0x02	Read	Binary	Unsigned. 1 = ON, 0 = Off.
Actuator status/channel 9 (bit 8)	10009	10008	0x02	Read	Binary	Unsigned. 1 = ON, 0 = Off.
Actuator status/channel 10 (bit 9)	10010	10009	0x02	Read	Binary	Unsigned. 1 = ON, 0 = Off.
Actuator status/channel 11 (bit 10)	10011	10010	0x02	Read	Binary	Unsigned. 1 = ON, 0 = Off.
Actuator status/channel 12 (bit 11)	10012	10011	0x02	Read	Binary	Unsigned. 1 = ON, 0 = Off.
Pump/Boiler (bit 12)	10013	10012	0x02	Read	Binary	Unsigned. 1 = ON, 0 = Off.
GPI status (bit 13)	10014	10013	0x02	Read	Binary	Unsigned. 1 = ON, 0 = Off.
Relative humidity (RH) cooling shutdown, channel 1	10015	10014	0x02	Read	Binary	Unsigned. 1 = Cooling shutdown, 0 = Cooling available.
Relative humidity (RH) cooling shutdown, channel 2	10016	10015	0x02	Read	Binary	Unsigned. 1 = Cooling shutdown, 0 = Cooling available.
Relative humidity (RH) cooling shutdown, channel 3	10017	10016	0x02	Read	Binary	Unsigned. 1 = Cooling shutdown, 0 = Cooling available.
Relative humidity (RH) cooling shutdown, channel 4	10018	10017	0x02	Read	Binary	Unsigned. 1 = Cooling shutdown, 0 = Cooling available.
Relative humidity (RH) cooling shutdown, channel 5	10019	10018	0x02	Read	Binary	Unsigned. 1 = Cooling shutdown, 0 = Cooling available.
Relative humidity (RH) cooling shutdown, channel 6	10020	10019	0x02	Read	Binary	Unsigned. 1 = Cooling shutdown, 0 = Cooling available.
Relative humidity (RH) cooling shutdown, channel 7	10021	10020	0x02	Read	Binary	Unsigned. 1 = Cooling shutdown, 0 = Cooling available.
Relative humidity (RH) cooling shutdown, channel 8	10022	10021	0x02	Read	Binary	Unsigned. 1 = Cooling shutdown, 0 = Cooling available.
Relative humidity (RH) cooling shutdown, channel 9	10023	10022	0x02	Read	Binary	Unsigned. 1 = Cooling shutdown, 0 = Cooling available.
Relative humidity (RH) cooling shutdown, channel 10	10024	10023	0x02	Read	Binary	Unsigned. 1 = Cooling shutdown, 0 = Cooling available.
Relative humidity (RH) cooling shutdown, channel 11	10025	10024	0x02	Read	Binary	Unsigned. 1 = Cooling shutdown, 0 = Cooling available.
Relative humidity (RH) cooling shutdown, channel 12	10026	10025	0x02	Read	Binary	Unsigned. 1 = Cooling shutdown, 0 = Cooling available.

## 3.5 Input Register data points

	<b>Note</b> All temperature data is sent in tenths of either Celsius or Fahrenheit, depending on the setting in U_BMS file.
	<b>Note</b> 0x7FFF is returned if no data is available for the channel.
	<b>Note</b> When reading the RH humidity value, the valid 0-100 % value is only shown in the lower byte. The higher byte could be masked or disregarded.



These datapoints are read only and show the current sensor value (temperature or humidity) for each channel (1 to 12) on the controller.

Display name	Register address (decimal)	Physical address (decimal)	Function code (Hex)	Type	Analogue/Binary	Coding
Controller outdoor temperature	30001	30000	0x04	Read	Analogue	Signed 16 bit integer.
Room temperature data, channel 1	30002	30001	0x04	Read	Analogue	Signed 16 bit integer.
Room temperature data, channel 2	30003	30002	0x04	Read	Analogue	Signed 16 bit integer.
Room temperature data, channel 3	30004	30003	0x04	Read	Analogue	Signed 16 bit integer.
Room temperature data, channel 4	30005	30004	0x04	Read	Analogue	Signed 16 bit integer.
Room temperature data, channel 5	30006	30005	0x04	Read	Analogue	Signed 16 bit integer.
Room temperature data, channel 6	30007	30006	0x04	Read	Analogue	Signed 16 bit integer.
Room temperature data, channel 7	30008	30007	0x04	Read	Analogue	Signed 16 bit integer.
Room temperature data, channel 8	30009	30008	0x04	Read	Analogue	Signed 16 bit integer.
Room temperature data, channel 9	30010	30009	0x04	Read	Analogue	Signed 16 bit integer.
Room temperature data, channel 10	30011	30010	0x04	Read	Analogue	Signed 16 bit integer.
Room temperature data, channel 11	30012	30011	0x04	Read	Analogue	Signed 16 bit integer.
Room temperature data, channel 12	30013	30012	0x04	Read	Analogue	Signed 16 bit integer.
Humidity data, channel 1	30014	30013	0x04	Read	Analogue	Unsigned 16 bit integer. 0-100 % relative humidity
Humidity data, channel 2	30015	30014	0x04	Read	Analogue	Unsigned 16 bit integer. 0-100 % relative humidity
Humidity data, channel 3	30016	30015	0x04	Read	Analogue	Unsigned 16 bit integer. 0-100 % relative humidity
Humidity data, channel 4	30017	30016	0x04	Read	Analogue	Unsigned 16 bit integer. 0-100 % relative humidity
Humidity data, channel 5	30018	30017	0x04	Read	Analogue	Unsigned 16 bit integer. 0-100 % relative humidity
Humidity data, channel 6	30019	30018	0x04	Read	Analogue	Unsigned 16 bit integer. 0-100 % relative humidity
Humidity data, channel 7	30020	30019	0x04	Read	Analogue	Unsigned 16 bit integer. 0-100 % relative humidity

Display name	Register address (decimal)	Physical address (decimal)	Function code (Hex)	Type	Analogue/ Binary	Coding
Humidity data, channel 8	30021	30020	0x04	Read	Analogue	Unsigned 16 bit integer. 0-100 % relative humidity
Humidity data, channel 9	30022	30021	0x04	Read	Analogue	Unsigned 16 bit integer. 0-100 % relative humidity
Humidity data, channel 10	30023	30022	0x04	Read	Analogue	Unsigned 16 bit integer. 0-100 % relative humidity
Humidity data, channel 11	30024	30023	0x04	Read	Analogue	Unsigned 16 bit integer. 0-100 % relative humidity
Humidity data, channel 12	30025	30024	0x04	Read	Analogue	Unsigned 16 bit integer. 0-100 % relative humidity
Floor temperature data, channel 1	30026	30025	0x04	Read	Analogue	Signed 16 bit integer.
Floor temperature data, channel 2	30027	30026	0x04	Read	Analogue	Signed 16 bit integer.
Floor temperature data, channel 3	30028	30027	0x04	Read	Analogue	Signed 16 bit integer.
Floor temperature data, channel 4	30029	30028	0x04	Read	Analogue	Signed 16 bit integer.
Floor temperature data, channel 5	30030	30029	0x04	Read	Analogue	Signed 16 bit integer.
Floor temperature data, channel 6	30031	30030	0x04	Read	Analogue	Signed 16 bit integer.
Floor temperature data, channel 7	30032	30031	0x04	Read	Analogue	Signed 16 bit integer.
Floor temperature data, channel 8	30033	30032	0x04	Read	Analogue	Signed 16 bit integer.
Floor temperature data, channel 9	30034	30033	0x04	Read	Analogue	Signed 16 bit integer.
Floor temperature data, channel 10	30035	30034	0x04	Read	Analogue	Signed 16 bit integer.
Floor temperature data, channel 11	30036	30035	0x04	Read	Analogue	Signed 16 bit integer.
Floor temperature data, channel 12	30037	30036	0x04	Read	Analogue	Signed 16 bit integer.
Thermostat loss	30038	30037	0x04	Read	Binary	Unsigned. 1 = Thermostat loss, 0 = No alarm.
Dynamic heat curve offset in integrated heat pump*	30039	30038	0x04	Read	Analogue	Signed 16 bit integer. +10 = 000A +1 = 0001 0 = 0000 -1 = 00FF -10 = 00F6

\* Requires **Heat Pump Integration via BMS** to be activated in U\_BMS.txt.

## 3.6 Holding Register data points

	<b>Note</b> All temperature data is sent in tenths of either Celsius or Fahrenheit, depending on the setting in U_BMS file.
	<b>Note</b> 0x7FFF is returned if no data is available for the channel.

These datapoints can be both read or written, and contain temperature setpoint and max/min temperature limits for each channel (1 to 12) on the controller.

Display name	Register address (decimal)	Physical address (decimal)	Function code (Hex)	Type	Analogue/ Binary	Coding
Room setpoint temperature, channel 1	40001	40000	0x03	Read	Analogue	Signed 16 bit integer. Range: min - max temperature, default: 21 °C (69.8 °F).
			0x06	Write		
			0x10	Write multiple		
Room setpoint temperature, channel 2	40002	40001	0x03	Read	Analogue	Signed 16 bit integer. Range: min - max temperature, default: 21 °C (69.8 °F).
			0x06	Write		
			0x10	Write multiple		
Room setpoint temperature, channel 3	40003	40002	0x03	Read	Analogue	Signed 16 bit integer. Range: min - max temperature, default: 21 °C (69.8 °F).
			0x06	Write		
			0x10	Write multiple		
Room setpoint temperature, channel 4	40004	40003	0x03	Read	Analogue	Signed 16 bit integer. Range: min - max temperature, default: 21 °C (69.8 °F).
			0x06	Write		
			0x10	Write multiple		
Room setpoint temperature, channel 5	40005	40004	0x03	Read	Analogue	Signed 16 bit integer. Range: min - max temperature, default: 21 °C (69.8 °F).
			0x06	Write		
			0x10	Write multiple		
Room setpoint temperature, channel 6	40006	40005	0x03	Read	Analogue	Signed 16 bit integer. Range: min - max temperature, default: 21 °C (69.8 °F).
			0x06	Write		
			0x10	Write multiple		
Room setpoint temperature, channel 7	40007	40006	0x03	Read	Analogue	Signed 16 bit integer. Range: min - max temperature, default: 21 °C (69.8 °F).
			0x06	Write		
			0x10	Write multiple		
Room setpoint temperature, channel 8	40008	40007	0x03	Read	Analogue	Signed 16 bit integer. Range: min - max temperature, default: 21 °C (69.8 °F).
			0x06	Write		
			0x10	Write multiple		
Room setpoint temperature, channel 9	40009	40008	0x03	Read	Analogue	Signed 16 bit integer. Range: min - max temperature, default: 21 °C (69.8 °F).
			0x06	Write		
			0x10	Write multiple		
Room setpoint temperature, channel 10	40010	40009	0x03	Read	Analogue	Signed 16 bit integer. Range: min - max temperature, default: 21 °C (69.8 °F).
			0x06	Write		
			0x10	Write multiple		
Room setpoint temperature, channel 11	40011	40010	0x03	Read	Analogue	Signed 16 bit integer. Range: min - max temperature, default: 21 °C (69.8 °F).
			0x06	Write		
			0x10	Write multiple		
Room setpoint temperature, channel 12	40012	40011	0x03	Read	Analogue	Signed 16 bit integer. Range: min - max temperature, default: 21 °C (69.8 °F).
			0x06	Write		
			0x10	Write multiple		
Room setpoint max temperature, channel 1	40013	40012	0x06	Write	Analogue	Signed 16 bit integer. Range: min temperature - 35, default: 35 °C (95 °F).
			0x10	Write multiple		
Room setpoint min temperature, channel 1	40014	40013	0x06	Write	Analogue	Signed 16 bit integer. Range: 5 - max temperature, default: 5 °C (41 °F).
			0x10	Write multiple		
Room setpoint max temperature, channel 2	40015	40014	0x06	Write	Analogue	Signed 16 bit integer. Range: min temperature - 35, default: 35 °C (95 °F).
			0x10	Write multiple		

Display name	Register address (decimal)	Physical address (decimal)	Function code (Hex)	Type	Analogue/ Binary	Coding
Room setpoint min temperature, channel 2	40016	40015	0x06	Write	Analogue	Signed 16 bit integer. Range: 5 - max temperature, default: 5 °C (41 °F).
			0x10	Write multiple		
Room setpoint max temperature, channel 3	40017	40016	0x06	Write	Analogue	Signed 16 bit integer. Range: min temperature - 35, default: 35 °C (95 °F).
			0x10	Write multiple		
Room setpoint min temperature, channel 3	40018	40017	0x06	Write	Analogue	Signed 16 bit integer. Range: 5 - max temperature, default: 5 °C (41 °F).
			0x10	Write multiple		
Room setpoint max temperature, channel 4	40019	40018	0x06	Write	Analogue	Signed 16 bit integer. Range: min temperature - 35, default: 35 °C (95 °F).
			0x10	Write multiple		
Room setpoint min temperature, channel 4	40020	40019	0x06	Write	Analogue	Signed 16 bit integer. Range: 5 - max temperature, default: 5 °C (41 °F).
			0x10	Write multiple		
Room setpoint max temperature, channel 5	40021	40020	0x06	Write	Analogue	Signed 16 bit integer. Range: min temperature - 35, default: 35 °C (95 °F).
			0x10	Write multiple		
Room setpoint min temperature, channel 5	40022	40021	0x06	Write	Analogue	Signed 16 bit integer. Range: 5 - max temperature, default: 5 °C (41 °F).
			0x10	Write multiple		
Room setpoint max temperature, channel 6	40023	40022	0x06	Write	Analogue	Signed 16 bit integer. Range: min temperature - 35, default: 35 °C (95 °F).
			0x10	Write multiple		
Room setpoint min temperature, channel 6	40024	40023	0x06	Write	Analogue	Signed 16 bit integer. Range: 5 - max temperature, default: 5 °C (41 °F).
			0x10	Write multiple		
Room setpoint max temperature, channel 7	40025	40024	0x06	Write	Analogue	Signed 16 bit integer. Range: min temperature - 35, default: 35 °C (95 °F).
			0x10	Write multiple		
Room setpoint min temperature, channel 7	40026	40025	0x06	Write	Analogue	Signed 16 bit integer. Range: 5 - max temperature, default: 5 °C (41 °F).
			0x10	Write multiple		
Room setpoint max temperature, channel 8	40027	40026	0x06	Write	Analogue	Signed 16 bit integer. Range: min temperature - 35, default: 35 °C (95 °F).
			0x10	Write multiple		
Room setpoint min temperature, channel 8	40028	40027	0x06	Write	Analogue	Signed 16 bit integer. Range: 5 - max temperature, default: 5 °C (41 °F).
			0x10	Write multiple		
Room setpoint max temperature, channel 9	40029	40028	0x06	Write	Analogue	Signed 16 bit integer. Range: min temperature - 35, default: 35 °C (95 °F).
			0x10	Write multiple		
Room setpoint min temperature, channel 9	40030	40029	0x06	Write	Analogue	Signed 16 bit integer. Range: 5 - max temperature, default: 5 °C (41 °F).
			0x10	Write multiple		
Room setpoint max temperature, channel 10	40031	40030	0x06	Write	Analogue	Signed 16 bit integer. Range: min temperature - 35, default: 35 °C (95 °F).
			0x10	Write multiple		
Room setpoint min temperature, channel 10	40032	40031	0x06	Write	Analogue	Signed 16 bit integer. Range: 5 - max temperature, default: 5 °C (41 °F).
			0x10	Write multiple		



Display name	Register address (decimal)	Physical address (decimal)	Function code (Hex)	Type	Analogue/ Binary	Coding
Room setpoint max temperature, channel 11	40033	40032	0x06	Write	Analogue	Signed 16 bit integer. Range: min temperature - 35, default: 35 °C (95 °F).
			0x10	Write multiple		
Room setpoint min temperature, channel 11	40034	40033	0x06	Write	Analogue	Signed 16 bit integer. Range: 5 - max temperature, default: 5 °C (41 °F).
			0x10	Write multiple		
Room setpoint max temperature, channel 12	40035	40034	0x06	Write	Analogue	Signed 16 bit integer. Range: min temperature - 35, default: 35 °C (95 °F).
			0x10	Write multiple		
Room setpoint min temperature, channel 12	40036	40035	0x06	Write	Analogue	Signed 16 bit integer. Range: 5 - max temperature, default: 5 °C (41 °F).
			0x10	Write multiple		
Room floor max limit temperature, channel 1	40037	40036	0x06	Write	Analogue	Signed 16 bit integer. Range: min temperature or 20 - 35, default: 26 °C (78.8 °F).
			0x10	Write multiple		
Room floor min limit temperature, channel 1	40038	40037	0x06	Write	Analogue	Signed 16 bit integer. Range: 10 - 30 or max temperature, default: 20 °C (68 °F).
			0x10	Write multiple		
Room floor max limit temperature, channel 2	40039	40038	0x06	Write	Analogue	Signed 16 bit integer. Range: min temperature or 20 - 35, default: 26 °C (78.8 °F).
			0x10	Write multiple		
Room floor min limit temperature, channel 2	40040	40039	0x06	Write	Analogue	Signed 16 bit integer. Range: 10 - 30 or max temperature, default: 20 °C (68 °F).
			0x10	Write multiple		
Room floor max limit temperature, channel 3	40041	40040	0x06	Write	Analogue	Signed 16 bit integer. Range: min temperature or 20 - 35, default: 26 °C (78.8 °F).
			0x10	Write multiple		
Room floor min limit temperature, channel 3	40042	40041	0x06	Write	Analogue	Signed 16 bit integer. Range: 10 - 30 or max temperature, default: 20 °C (68 °F).
			0x10	Write multiple		
Room floor max limit temperature, channel 4	40043	40042	0x06	Write	Analogue	Signed 16 bit integer. Range: min temperature or 20 - 35, default: 26 °C (78.8 °F).
			0x10	Write multiple		
Room floor min limit temperature, channel 4	40044	40043	0x06	Write	Analogue	Signed 16 bit integer. Range: 10 - 30 or max temperature, default: 20 °C (68 °F).
			0x10	Write multiple		
Room floor max limit temperature, channel 5	40045	40044	0x06	Write	Analogue	Signed 16 bit integer. Range: min temperature or 20 - 35, default: 26 °C (78.8 °F).
			0x10	Write multiple		
Room floor min limit temperature, channel 5	40046	40045	0x06	Write	Analogue	Signed 16 bit integer. Range: 10 - 30 or max temperature, default: 20 °C (68 °F).
			0x10	Write multiple		
Room floor max limit temperature, channel 6	40047	40046	0x06	Write	Analogue	Signed 16 bit integer. Range: min temperature or 20 - 35, default: 26 °C (78.8 °F).
			0x10	Write multiple		
Room floor min limit temperature, channel 6	40048	40047	0x06	Write	Analogue	Signed 16 bit integer. Range: 10 - 30 or max temperature, default: 20 °C (68 °F).
			0x10	Write multiple		
Room floor max limit temperature, channel 7	40049	40048	0x06	Write	Analogue	Signed 16 bit integer. Range: min temperature or 20 - 35, default: 26 °C (78.8 °F).
			0x10	Write multiple		

Display name	Register address (decimal)	Physical address (decimal)	Function code (Hex)	Type	Analogue/ Binary	Coding
Room floor min limit temperature, channel 7	40050	40049	0x06	Write	Analogue	Signed 16 bit integer. Range: 10 - 30 or max temperature, default: 20 °C (68 °F).
			0x10	Write multiple		
Room floor max limit temperature, channel 8	40051	40050	0x06	Write	Analogue	Signed 16 bit integer. Range: min temperature or 20 - 35, default: 26 °C (78.8 °F).
			0x10	Write multiple		
Room floor min limit temperature, channel 8	40052	40051	0x06	Write	Analogue	Signed 16 bit integer. Range: 10 - 30 or max temperature, default: 20 °C (68 °F).
			0x10	Write multiple		
Room floor max limit temperature, channel 9	40053	40052	0x06	Write	Analogue	Signed 16 bit integer. Range: min temperature or 20 - 35, default: 26 °C (78.8 °F).
			0x10	Write multiple		
Room floor min limit temperature, channel 9	40054	40053	0x06	Write	Analogue	Signed 16 bit integer. Range: 10 - 30 or max temperature, default: 20 °C (68 °F).
			0x10	Write multiple		
Room floor max limit temperature, channel 10	40055	40054	0x06	Write	Analogue	Signed 16 bit integer. Range: min temperature or 20 - 35, default: 26 °C (78.8 °F).
			0x10	Write multiple		
Room floor min limit temperature, channel 10	40056	40055	0x06	Write	Analogue	Signed 16 bit integer. Range: 10 - 30 or max temperature, default: 20 °C (68 °F).
			0x10	Write multiple		
Room floor max limit temperature, channel 11	40057	40056	0x06	Write	Analogue	Signed 16 bit integer. Range: min temperature or 20 - 35, default: 26 °C (78.8 °F).
			0x10	Write multiple		
Room floor min limit temperature, channel 11	40058	40057	0x06	Write	Analogue	Signed 16 bit integer. Range: 10 - 30 or max temperature, default: 20 °C (68 °F).
			0x10	Write multiple		
Room floor max limit temperature, channel 12	40059	40058	0x06	Write	Analogue	Signed 16 bit integer. Range: min temperature or 20 - 35, default: 26 °C (78.8 °F).
			0x10	Write multiple		
Room floor min limit temperature, channel 12	40060	40059	0x06	Write	Analogue	Signed 16 bit integer. Range: 10 - 30 or max temperature, default: 20 °C (68 °F).
			0x10	Write multiple		
Comfort setting, channel 1	40061	40060	0x03	Read	Analogue	Signed 16 bit integer. Range: 0 = off, 5 - 12 = 5 - 12 % default: 0.
			0x06	Write		
			0x10	Write multiple		
Comfort setting, channel 2	40062	40061	0x03	Read	Analogue	Signed 16 bit integer. Range: 0 = off, 5 - 12 = 5 - 12 % default: 0.
			0x06	Write		
			0x10	Write multiple		
Comfort setting, channel 3	40063	40062	0x03	Read	Analogue	Signed 16 bit integer. Range: 0 = off, 5 - 12 = 5 - 12 % default: 0.
			0x06	Write		
			0x10	Write multiple		
Comfort setting, channel 4	40064	40063	0x03	Read	Analogue	Signed 16 bit integer. Range: 0 = off, 5 - 12 = 5 - 12 % default: 0.
			0x06	Write		
			0x10	Write multiple		
Comfort setting, channel 5	40065	40064	0x03	Read	Analogue	Signed 16 bit integer. Range: 0 = off, 5 - 12 = 5 - 12 % default: 0.
			0x06	Write		
			0x10	Write multiple		
Comfort setting, channel 6	40066	40065	0x03	Read	Analogue	Signed 16 bit integer.

Display name	Register address (decimal)	Physical address (decimal)	Function code (Hex)	Type	Analogue/ Binary	Coding
			0x06	Write		Range: 0 = off, 5 - 12 = 5 - 12 % default: 0.
			0x10	Write multiple		
Comfort setting, channel 7	40067	40066	0x03	Read	Analogue	Signed 16 bit integer.
			0x06	Write		Range: 0 = off, 5 - 12 = 5 - 12 %
			0x10	Write multiple		default: 0.
Comfort setting, channel 8	40068	40067	0x03	Read	Analogue	Signed 16 bit integer.
			0x06	Write		Range: 0 = off, 5 - 12 = 5 - 12 %
			0x10	Write multiple		default: 0.
Comfort setting, channel 9	40069	40068	0x03	Read	Analogue	Signed 16 bit integer.
			0x06	Write		Range: 0 = off, 5 - 12 = 5 - 12 %
			0x10	Write multiple		default: 0.
Comfort setting, channel 10	40070	40069	0x03	Read	Analogue	Signed 16 bit integer.
			0x06	Write		Range: 0 = off, 5 - 12 = 5 - 12 %
			0x10	Write multiple		default: 0.
Comfort setting, channel 11	40071	40070	0x03	Read	Analogue	Signed 16 bit integer.
			0x06	Write		Range: 0 = off, 5 - 12 = 5 - 12 %
			0x10	Write multiple		default: 0.
Comfort setting, channel 12	40072	40071	0x03	Read	Analogue	Signed 16 bit integer.
			0x06	Write		Range: 0 = off, 5 - 12 = 5 - 12 %
			0x10	Write multiple		default: 0.
Heating/cooling offset temperature	40073	40072	0x03	Read	Analogue	Signed 16 bit integer.
			0x06	Write		Range: 0 - 5 °C
			0x10	Write multiple		default: 2 °C (2 °F).
Relative humidity (RH) dead zone (hysteresis)	40074	40073	0x03	Read	Analogue	Unsigned 16 bit integer.
			0x06	Write		Range: 2 - 20 = 2 - 20 %
			0x10	Write multiple		default: 5 %
Relative humidity (RH) setpoint, channel 1	40075	40074	0x03	Read	Analogue	Unsigned 16 bit integer.
			0x06	Write		Range: 0 - 100 = 0 - 100 %
			0x10	Write multiple		default: 75 %
Relative humidity (RH) setpoint, channel 2	40076	40075	0x03	Read	Analogue	Unsigned 16 bit integer.
			0x06	Write		Range: 0 - 100 = 0 - 100 %
			0x10	Write multiple		default: 75 %
Relative humidity (RH) setpoint, channel 3	40077	40076	0x03	Read	Analogue	Unsigned 16 bit integer.
			0x06	Write		Range: 0 - 100 = 0 - 100 %
			0x10	Write multiple		default: 75 %
Relative humidity (RH) setpoint, channel 4	40078	40077	0x03	Read	Analogue	Unsigned 16 bit integer.
			0x06	Write		Range: 0 - 100 = 0 - 100 %
			0x10	Write multiple		default: 75 %
Relative humidity (RH) setpoint, channel 5	40079	40078	0x03	Read	Analogue	Unsigned 16 bit integer.
			0x06	Write		Range: 0 - 100 = 0 - 100 %
			0x10	Write multiple		default: 75 %
Relative humidity (RH) setpoint, channel 6	40080	40079	0x03	Read	Analogue	Unsigned 16 bit integer.
			0x06	Write		Range: 0 - 100 = 0 - 100 %
			0x10	Write multiple		default: 75 %

Display name	Register address (decimal)	Physical address (decimal)	Function code (Hex)	Type	Analogue/Binary	Coding
Relative humidity (RH) setpoint, channel 7	40081	40080	0x03	Read	Analogue	Unsigned 16 bit integer. Range: 0 - 100 = 0 - 100 % default: 75 %
			0x06	Write		
			0x10	Write multiple		
Relative humidity (RH) setpoint, channel 8	40082	40081	0x03	Read	Analogue	Unsigned 16 bit integer. Range: 0 - 100 = 0 - 100 % default: 75 %
			0x06	Write		
			0x10	Write multiple		
Relative humidity (RH) setpoint, channel 9	40083	40082	0x03	Read	Analogue	Unsigned 16 bit integer. Range: 0 - 100 = 0 - 100 % default: 75 %
			0x06	Write		
			0x10	Write multiple		
Relative humidity (RH) setpoint, channel 10	40084	40083	0x03	Read	Analogue	Unsigned 16 bit integer. Range: 0 - 100 = 0 - 100 % default: 75 %
			0x06	Write		
			0x10	Write multiple		
Relative humidity (RH) setpoint, channel 11	40085	40084	0x03	Read	Analogue	Unsigned 16 bit integer. Range: 0 - 100 = 0 - 100 % default: 75 %
			0x06	Write		
			0x10	Write multiple		
Relative humidity (RH) setpoint, channel 12	40086	40085	0x03	Read	Analogue	Unsigned 16 bit integer. Range: 0 - 100 = 0 - 100 % default: 75 %
			0x06	Write		
			0x10	Write multiple		

# 4 Troubleshooting

In case of problems and alarms in the Uponor Smatrix Base PRO system, check the table below.

Otherwise see *Uponor Smatrix Base PRO installation and operation manual section 16* for more information.

## 4.1 No communication between controller and BMS

Changes done in BMS are not carried out in the controller and/or thermostats

- Missing U\_BMS.txt file
  - Download the file from the Uponor website and copy it onto the microSD card
- U\_BMS.txt file not configured correctly
  - Configure the U\_BMS.txt file correctly  
See *Preparation, Page 3* step 3, for more information
- Incorrect software version in the controller
  - Install the correct software in the controller  
See *Preparation, Page 3* step 2, for more information
- Disconnected communication cable
  - Check all wiring to make sure all communication cables are connected correctly

## 4.2 Slow communication, or high latency, between Uponor system and BMS

It takes a long time for Uponor parameters to change in the after being sent from the BMS

- The Uponor Smatrix Base PRO Interface I-147 is installed and registered in the system
  - Unregister and disconnect the interface from the Uponor system

## 4.3 Wrong parameters changed in Uponor system compared to BMS settings

Wrong parameters are changed in the Uponor system after new values are sent from the BMS

- The Uponor Smatrix Base PRO Interface I-147 is installed and registered in the system
  - Unregister and disconnect the interface from the Uponor system





# Uponor

**Uponor GmbH**

Industriestraße 56,  
D-97437 Hassfurt, Germany

1090255 v4\_11\_2020\_EN  
Production: Uponor/ELO

Uponor reserves the right to make changes, without prior notification,  
to the specification of incorporated components in line with its policy of  
continuous improvement and development.



[www.uponor.com](http://www.uponor.com)