

## Uponor Smatrix Wave X-165 Uponor Smatrix Base PRO X-147

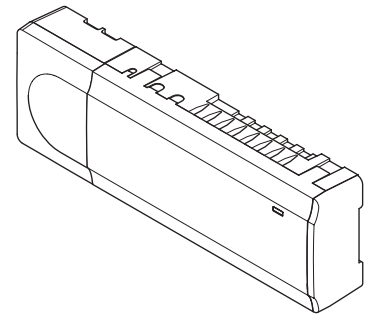

### Room controller Software Upgrade Preparation

This document describes how to upgrade the software on the Uponor Smatrix Wave/Base PRO room controllers.

#### Safety instructions

	<b>Caution!</b> Do not remove the microSD card while the room controller is powered on.
	<b>Caution!</b> Make sure the same microSD card is inserted in the room controller when the upgrade is finished. Otherwise your installation might stop working.
	<b>Caution!</b> Before starting the room controller upgrade, save a copy of U_BACKUP.TXT (contains registration information) from the microSD card to the computer hard drive.
	<b>Caution!</b> Do not have the microSD card inserted in the room controller when entering registration mode during fault finding. Otherwise U_BACKUP.TXT will be overwritten.
	<b>Note</b> Make sure to have a microSD adapter or reader handy. It is needed for to transfer the software to the microSD card.
	<b>Note</b> If upgrading several room controllers a separate, newly formatted, microSD card can be used for all room controllers.  Eject the existing microSD card, upgrade using the separate card, and reinsert the original microSD card when done.  Repeat the process for all room controllers.

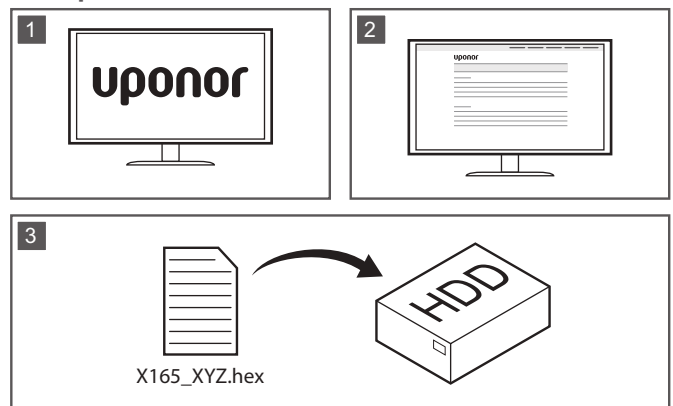

To prepare the upgrade process, either use the software supplied by the local Uponor support or:

1. Go to the local Uponor website.
2. Locate the upgrade page for Uponor Smatrix Wave/Base PRO, and check if there are any new upgrades available.
3. Download the latest version of the software.

# Upgrading

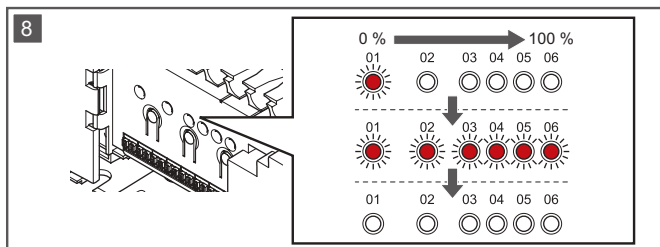
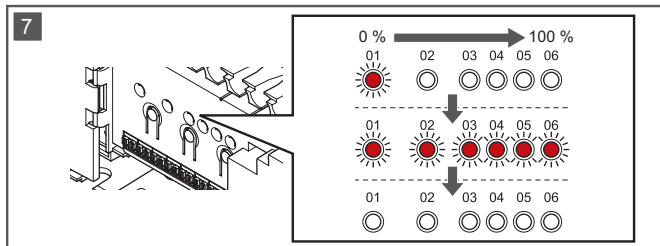
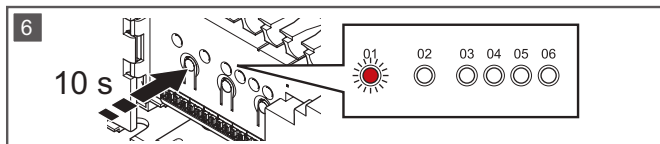
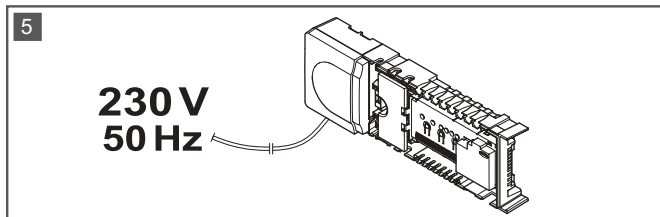
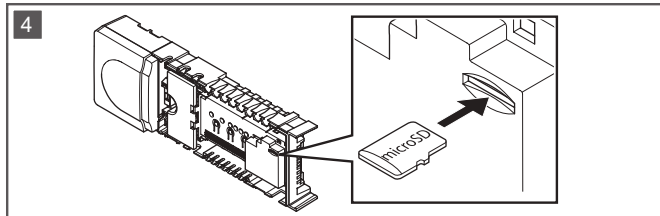
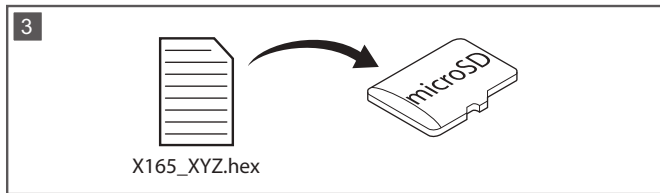
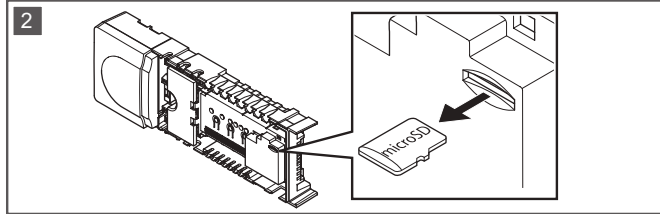
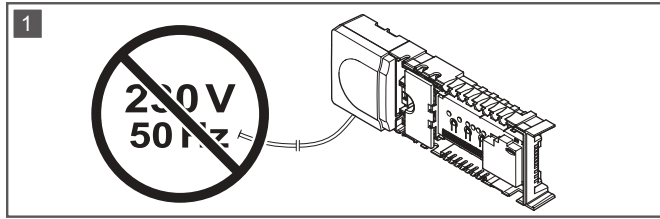

## Note

Finish the preparation steps, and read the safety instructions, before upgrading.

To upgrade the room controller software:

1. Power off the room controller.
2. Eject the microSD card from the room controller.
3. Copy the file (Wave: X165\_XYZ.hex, Base PRO: X147\_XYZ.hex, where XYZ is the current version number) to the microSD card, or use the microSD card provided by Uponor.
4. Insert the microSD card into the room controller.
5. Power on the room controller
6. Press and hold the < button on the room controller until all channel LEDs except channel 1 turn off.

**NOTE!** If all LEDs on the room controller flashes once and exits to run mode, the software on the microSD card and on the room controller is already of the same version.

7. The upgrade process is now activated. The progress of the upgrade is indicated with red channel LEDs on the room controller counting up.

**NOTE!** This process will take several minutes.

When all progress LEDs is lit, the room controller restarts.

8. The second and final phase of the upgrade is activated and the progress is once again indicated by the red channel LEDs on the room controller counting up.

**NOTE!** This process will take a couple of minutes.

When all progress LEDs is lit again, the room controller enters run mode and the upgrade is finished.

# Troubleshooting

## Registration information lost after upgrade



### Note

This solution only applies to Uponor Smatrix Wave room controllers with version v1.15 or later.

Older installations can be recovered by upgrading to v1.15 and using the solution below (from step 2).

### Solution:

1. Restart the room controller (power off and on again) with the microSD card inserted.  
The installation data should now be recovered. If not go to step 2.
2. Power off the room controller and eject the microSD card.
3. Insert the microSD card into a computer and locate U\_BACKUP.TXT.
4. Save a copy of U\_BACKUP.TXT renamed to W\_TEMP.TXT on the SD card, and insert it into the room controller again.
5. Power on the room controller.  
The registration information is now restored in the room controller.

## The second and final phase (step 8 in the upgrade instruction) of the reprogramming did not start

### Solution:

1. Power off the room controller and eject the microSD card.
2. Power on the room controller.
3. Verify that the final phase (step 8 in the upgrade instruction) of the reprogramming start again.  
The LEDs on the room controller will light up again, starting with channel 1 LED. When all LEDs are turned off again, the upgrade is finished.
4. Power off the room controller and insert the microSD card.  
**NOTE!** This step must be done otherwise the room controller will not be able to restore the installation data (registration information).
5. Power on the controller again.  
The registration information is now restored.  
**NOTE!** If the registration information is not restored after the powering on the room controller again, see *Installation data lost after upgrade* for more information.

## The installation stopped working after the upgrade

### Cause:

- The microSD card might have become corrupted and/or mixed up. Try running the room controller without the microSD card. If the room controller works without the microSD card, restore the microSD card as follows.

### Solution:

1. Use a computer to format the microSD card (FAT32).
2. Insert the newly formatted microSD card into the room controller and power it up.
3. Press and hold the **OK** button on the room controller until one of the channel LEDs starts flashing.
4. Press and hold the **OK** button on the room controller once again until the green channel LEDs turn off.  
The registration information is now saved on a backup on the microSD card.

**Uponor GmbH**

Industriestraße 56,  
D-97437 Hassfurt, Germany

1091819 v2\_07\_2020  
Production: Uponor / MRY

Uponor reserves the right to make changes, without prior notification,  
to the specification of incorporated components in line with its policy  
of continuous improvement and development.



[www.uponor.com](http://www.uponor.com)